

Инструкция по сборке
Instructions for assembling furniture
Instrukcja montażu mebli

Набор мебели для Collection Kolekcja mebli
общей комнаты

«VALENCIA»

Шкаф с витриной 2V2D1S

Cabinet-showcase 2V2D1S

Szafa-witryna 2V2D1S

AH-075.13.00.00

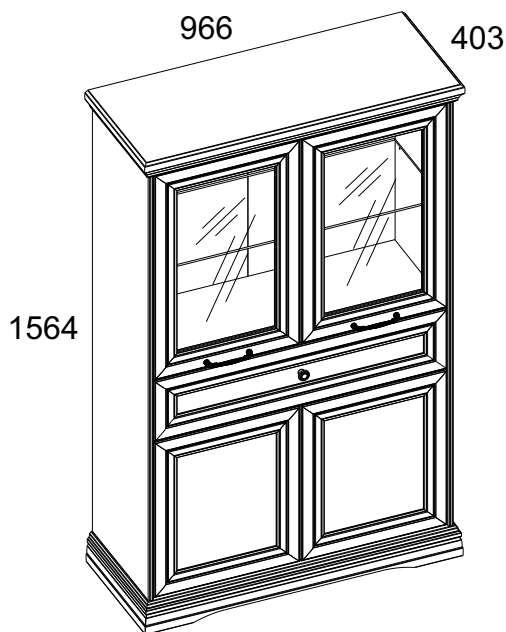

Дата изготовления
Production date
Data produkcji

Штамп ОТК
Stamp of Quality Department
Pieczęć Działu Jakości

ИООО « АНРЭКС »

Республика Беларусь, 224004
г.Брест, ул. Катин Бор, 119
тел/факс (+375162) 30-17-07



ЕАЭС № TC BY/112 11.01. TP025 018.01 00802
от 15.03.2022
по 14.03.2027

Инструкция по эксплуатации.

Качество и комплектность изделия рекомендуется проверять в магазине при покупке в распакованном виде. Сборка изделия должна производиться в порядке, изложенном в настоящей инструкции. В процессе эксплуатации изделий необходимо периодически затягивать ослабленные винтовые соединения. В случае необходимости перемещения изделия по квартире перед его перестановкой, необходимо полностью освободить его от груза (матраца). Во избежание поломок имеющих опор передвигание производить приподнимая изделие над уровнем пола. Запрещён прямой контакт с водой. Удаление пыли с изделий следует производить слегка влажной мягкой салфеткой. Во избежание коробления деталей и изменения цвета изделия следует избегать установки мебели на прямых солнечных лучах.

При эксплуатации изделий набора **ЗАПРЕЩАЕТСЯ:**

- устанавливать мебель вблизи отопительных приборов и вплотную к сырým стенам и в помещениях с относительной влажностью более 70%;
- температура нагрева элементов мебели не должна превышать +40 °С.
- в процессе сборки и эксплуатации изделий набора становиться ногами на горизонтальные щиты и витрины;
- применять химические чистящие средства для уборки мебели;

Гарантии изготовителя.

1. Гарантийный срок эксплуатации изделия - 24 месяца со дня продажи магазином. В период гарантийного срока изготовитель гарантирует ремонт изделий или их замену, если потребителем не нарушены правила эксплуатации.
2. Претензии предъявляются потребителем непосредственно в торгующую организацию, в которой была приобретена мебель, предъявив настоящую "Инструкцию по сборке" и копию товарного чека.
3. Изделие **Шкаф с витриной 2V2D1S**, входящее в состав набора мебели для общей комнаты **«VALENCIA»**, соответствует требованиям ГОСТ 16371-2014, ТР ТС 025/2012.
4. Срок службы мебели - 5 лет.
5. Предприятие-изготовитель оставляет за собой право вносить изменения в конструкцию изделия, не ухудшая его конструктивные и эксплуатационные характеристики.
6. Для сборки изделий рекомендуется привлекать квалифицированных специалистов.

Запах.

От новой мебели может исходить запах материалов, из которых она изготовлена. Запах может сохраняться в течение трёх недель с момента сборки. Для снижения интенсивности запаха рекомендуется:

-для мягкой мебели - пропылесосить изделие и проветрить помещение.

Повторять 3-4 раза в день.

-для корпусной мебели – протирать тканью, смоченной мягким моющим средством, вытирать чистой сухой тканью и проветривать помещение, предварительно открывая все двери и ящики изделия.

Повторять 3-4 раза в день.

Важно! Сохраните, пожалуйста, инструкцию в случае повторной сборки мебели или рекламации. В случае составления рекламации пользуйтесь, пожалуйста, обозначением из инструкции сборки.

PL

Przy eksploatacji mebli zabrania się:

- ustawiać meble w pobliżu grzewczych przyrządów i obok wilgotnych ścian, a także w pomieszczeniach ze względną wilgotnością więcej niż 70%;
- temperatura nagrzewania elementów mebli nie może przekraczać +40°C;
- w trakcie montażu i eksploatacji mebli stawać nogami na poziome panele i witryny;
- stosować chemiczne środki czyszczące do sprzątania mebli;
- nie należy narażać na kontakt z wodą.

Gwarancje producenta.

1. Gwarancyjny termin eksploatacji wyrobu - 24 miesiące z dnia sprzedaży. W okresie gwarancyjnego terminu producent gwarantuje naprawę wyrobów lub ich zamianę, jeżeli reguły eksploatacji nie zostały naruszone przez nabywcę.
2. Roszczenia są przekazywane przez nabywcę bezpośrednio do handlującej organizacji, w której były nabyte meble, tylko przy okazaniu danej "Instrukcji montażu" wraz z dokumentem zakupu.
3. Wyrób, **Szafa-witryna 2V2D1S** wchodzące w zestaw mebli "**VALENCIA**", odpowiada wymaganiom Norm Państwowych 16371-2014, TP TC 025/2012
4. Trwałość użytkowa mebli - 5 lat.
5. Firma-producent pozostawia za sobą prawo do wprowadzania zmian w konstrukcje wyrobów, nie pogarszając ich konstruktywne i eksploatacyjne charakterystyki.
6. Do montażu wyrobów zaleca się skorzystanie z pomocy wykwalifikowanych specjalistów.

Zapach.

Nowe meble mogą wydzielać zapach materiałów, z których są wykonane. Zapach może utrzymywać się do trzech tygodni od momentu montażu. Aby zmniejszyć intensywność zapachu, zaleca się:

- w przypadku mebli tapicerowanych - odkurzyć produkt i przewietrzyć pomieszczenie.

Powtarzaj 3-4 razy dziennie.

- dla mebli szafkowych - przetrzyj ściereczką zwilżoną łagodnym detergentem, przetrzyj czystą, suchą ściereczką i przewietrz pomieszczenie, uprzednio otwierając wszystkie drzwi i szuflady produktu.

Powtarzaj 3-4 razy dziennie.

Ważne! Proszę zachować instrukcję w razie ponownego montażu mebli lub reklamacji. Podczas składania reklamacji prosimy o korzystanie z oznaczeń z instrukcji.

EN

Instruction manual.

It's advised to check the quality and completeness of the product in the store when buying unpacked. Assembling of the product should be done the way it's described in this manual. While the product is in service loose screw connections should be periodically tightened. If it's necessary to move items around the apartment before moving you should release the product completely from the load (the mattress). To prevent damage to existing supports the product should be lifted before moving. Furniture should not be exposed to contact with water. Dusting the product should be done with a slightly damp soft cloth. To prevent warping of parts and discoloration of products do not install furniture in direct sunlight.

While the product is in service it's PROHIBITED TO:

- Install furniture near heating devices, close to the raw walls and in rooms with a relative humidity of more than 70%;
- heat elements of furniture to the temperature higher +40°C;
- step on the horizontal shields and windows during assembly and use of the products set;
- use chemical cleaners for cleaning furniture;

Manufacturer's warranty.

1. The warranty period of use of the product - 24 months from the date of sale. During the warranty period the manufacturer guarantees repair or replacement of products, if the user has not violated operating rules.
2. Claims should be made by the consumer directly to the trading organization, in which furniture was purchased, presenting the "Instruction manual" and a copy of the sales receipt.
3. The product **Cabinet-showcase 2V2D1S**, which is part of a set of "**VALENCIA**", meet the requirements of GOST 16371-2014, TR TS 025/2012.
4. The lifetime of furniture - 5 years.
5. The manufacturer reserves the right to make changes in product design, without compromising its design and application requirements.
6. To assemble the products it's recommended to attract qualified personnel.

Smell.

New furniture may emit the smell of the materials from which it is made. The smell can persist for up to three weeks from the time of assembly. To reduce odor intensity, it is recommended:

- for upholstered furniture - vacuum the product and ventilate the room.

Repeat 3-4 times a day.

- for cabinet furniture - wipe with a cloth dampened in a mild detergent, wipe with a clean, dry cloth and ventilate the room, previously opening all doors and drawers of the product.

Repeat 3-4 times a day.

It is important! Keep the instruction in case of reassembly of furniture or complaint. When making a claim use the notation from the instruction.

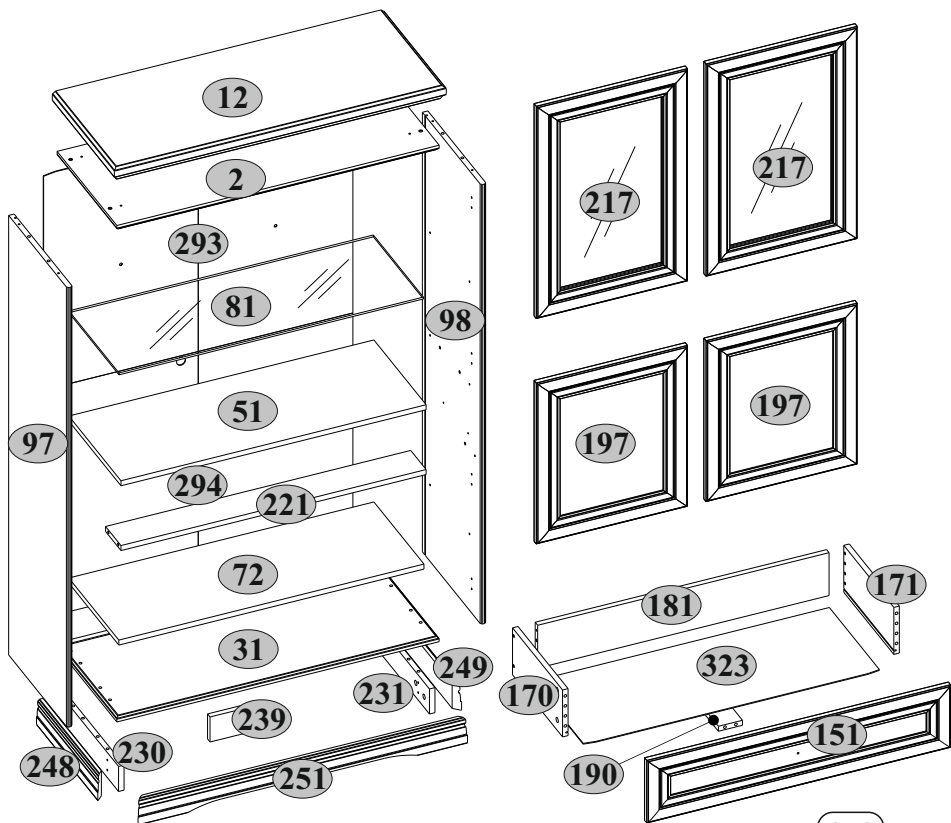

Элемент для докупки (O2, O3)*
 Dodatkowe elementy do zakupu (O2, O3)*
 Additional element for buy (O2, O3)*

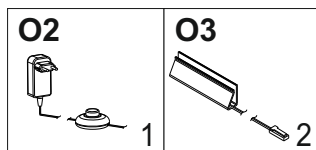

22

23







24

№ п/п	Длина мм	Ширина мм	Толщина мм	Кол-во шт.	№ пачки
2	938	388	16	1	1/3
12	966	403	44	1	1/3
31	938	388	16	1	1/3
51	888	342	16	1	1/3
72	888	325	16	1	1/3
81	886	325	6	1	1/3
97	1404	380	16	1	2/3
98	1404	380	16	1	2/3
151	884	200	19	1	2/3
170	325	150	16	1	2/3
171	325	150	16	1	2/3
239	100	80	16	1	2/3
248	398	80	19	1	2/3
251	958	80	19	1	2/3
293	688	900	2,5	1	3/3
294	728	900	2,5	1	3/3
190	325	70	16	1	2/3

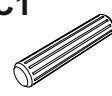
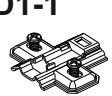
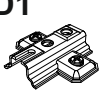
№ п/п	Длина мм	Ширина мм	Толщина мм	Кол-во шт.	№ пачки
197	440	514	19	2	3/3
217	678	440	19	2	3/3
221	888	100	16	1	2/3
230	379	80	16	1	2/3
231	379	80	16	1	2/3
239	100	80	16	1	2/3
249	398	80	19	1	2/3
323	862	330	2,5	1	1/3



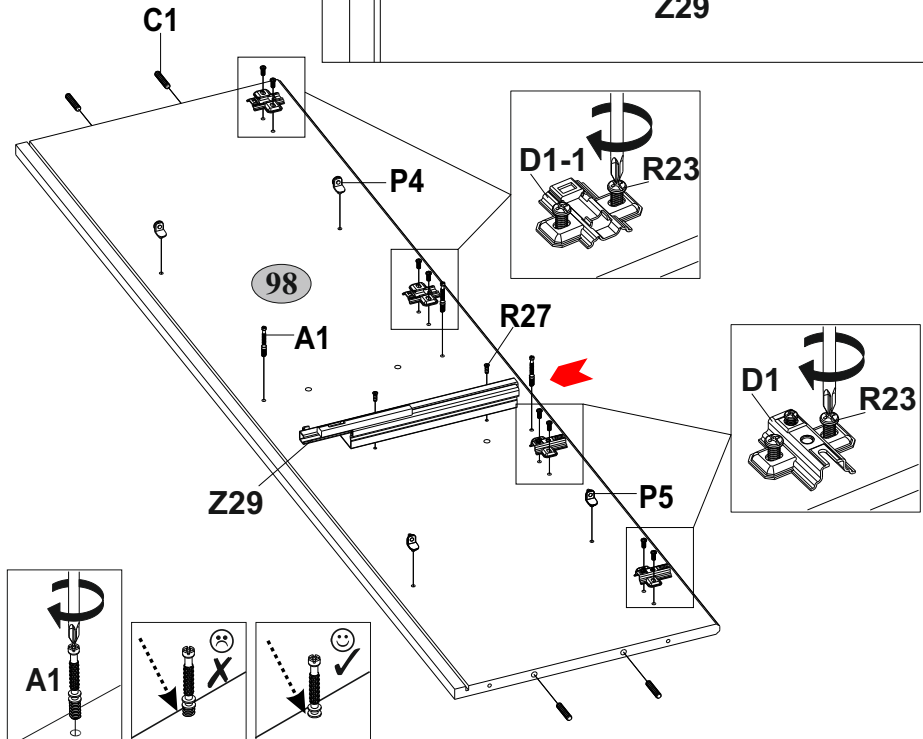
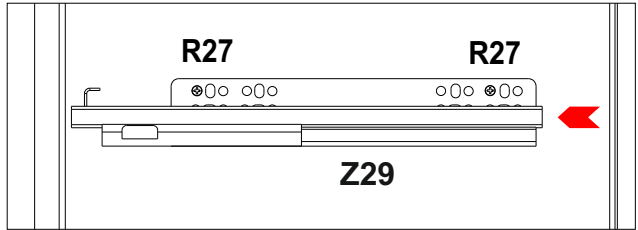
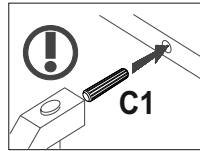
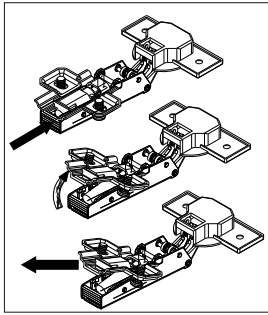

	A1 7x34 17	A2 Ø15x12 17	B5 10x50 1	C1 8x35 29	
	D1 4	D1-1 4	E6 4	E6-1 4	
	H55 2	H56 1	I S4 1	M1 M4x12 1	
	M4 M4x22 4	N1 5	P4 4	P5 4	
	Q4 1	Q10 2	Q11 2	R3 3x20 10	
	R9 4x25 8	R12 4x40 2	R23 6,3x13 16	R24 7x50 14	
	R27 5,0x13 4	R105 3,5x30 4	R102 3,5x16 24	S1 20	
	S3 4	S5 Ø18 6	S8 Ø14 8	S11 Ø8 4	
U 130x35x15 1	U10 2	Z29 300 1			

1

A1  7x34 3	C1  8x35 4	D1-1  2	D1  2	P4  2
P5  2	R23  6,3x13 8	R27  5,0x13 2	Z29  300 1	

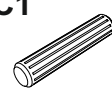
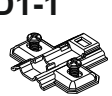
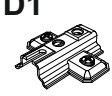
E6-1+D1-1

2

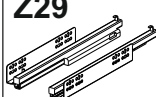
A1  7x34 3	C1  8x35 4	D1-1  2	D1  2	P4  2
P5  2	R23  6,3x13 8	R27  5,0x13 2	Z29  300 1	

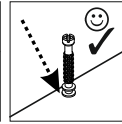
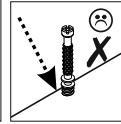
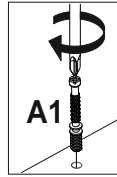
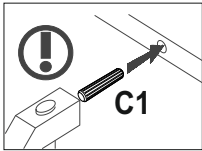
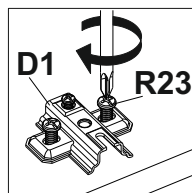
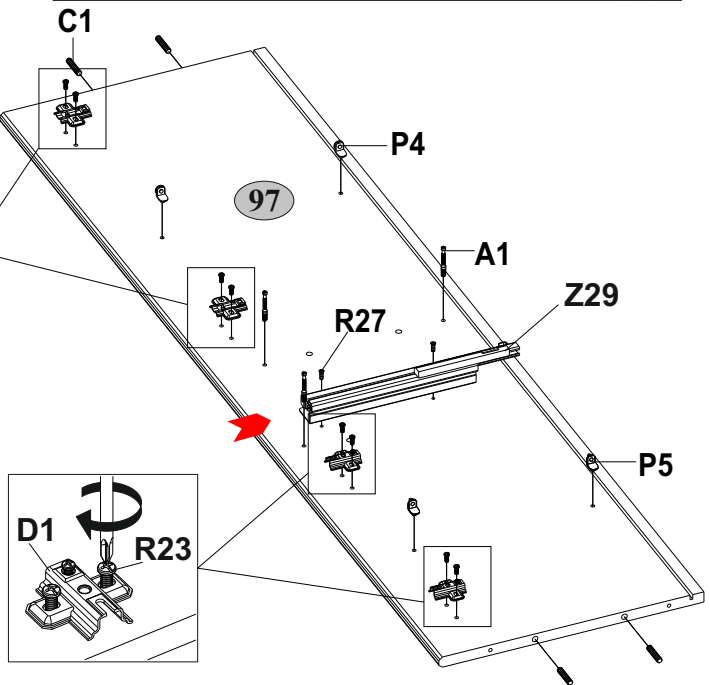
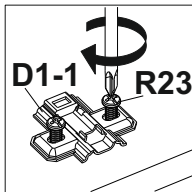
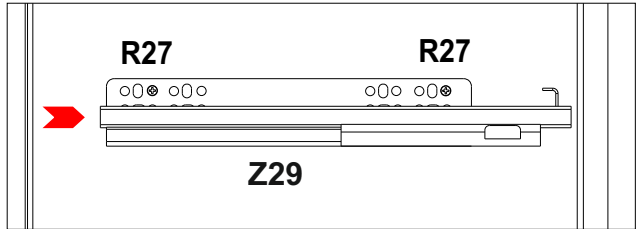
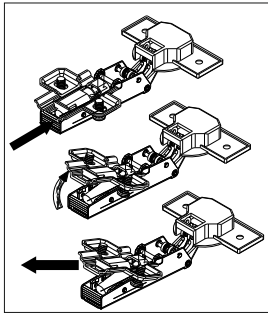
**E6-1+D1-1**

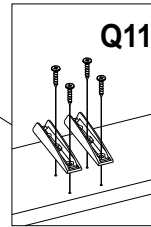
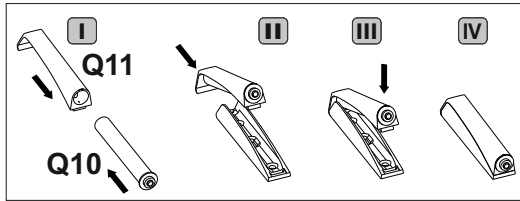
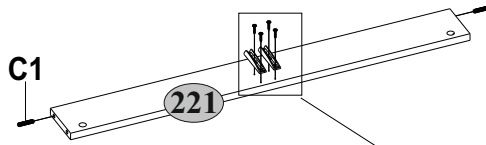
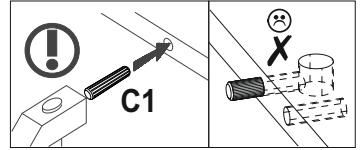
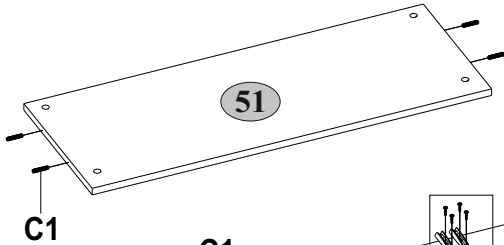
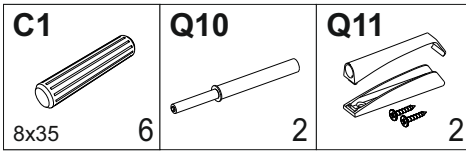
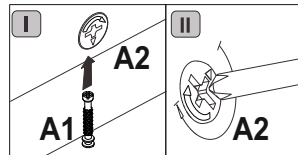
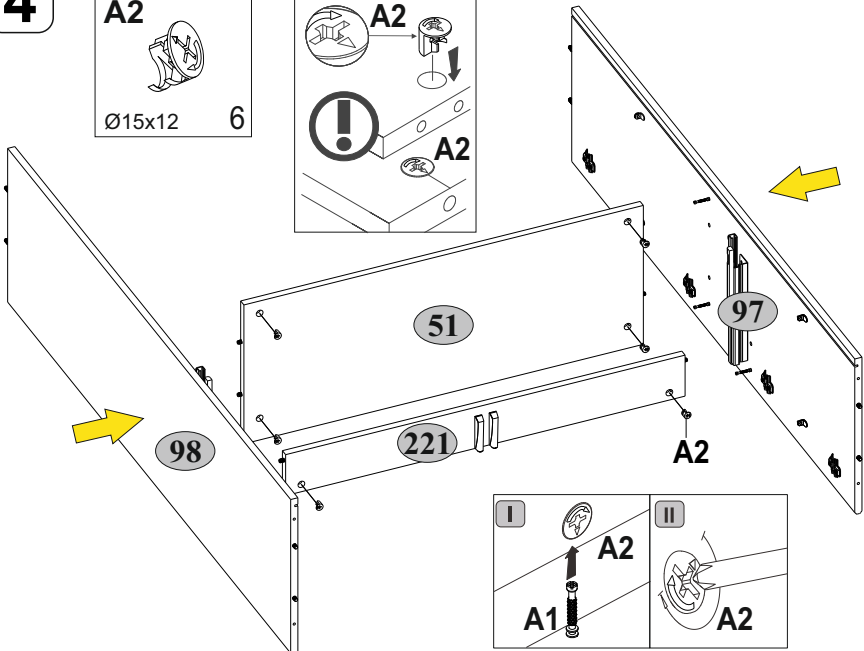
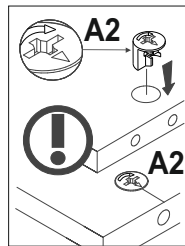
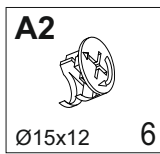
3**4**

5

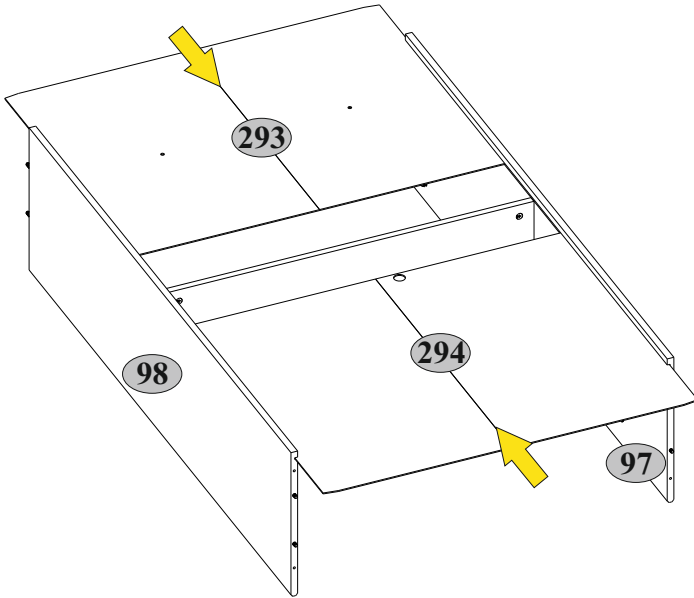

6

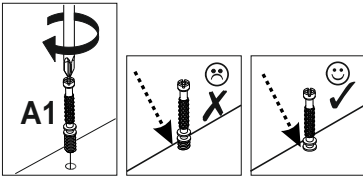
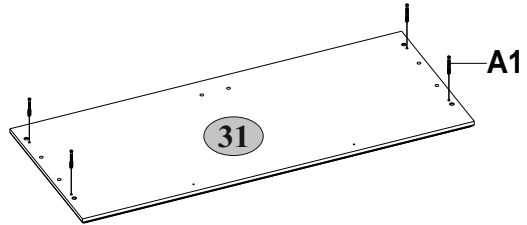
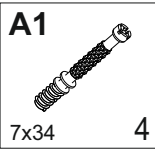

7

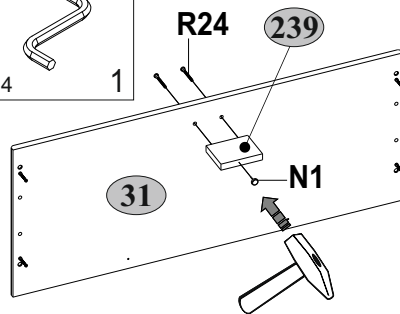
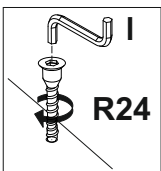
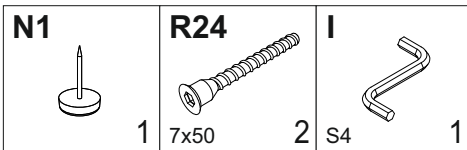

8

Q4

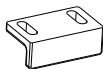

1

R102



3,5x16

2

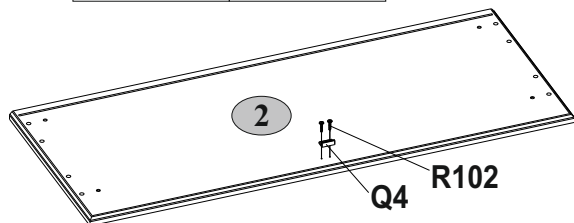

R102



Q4

9

R24

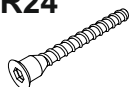

7x50

8

I



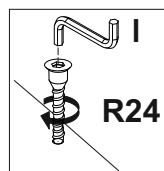
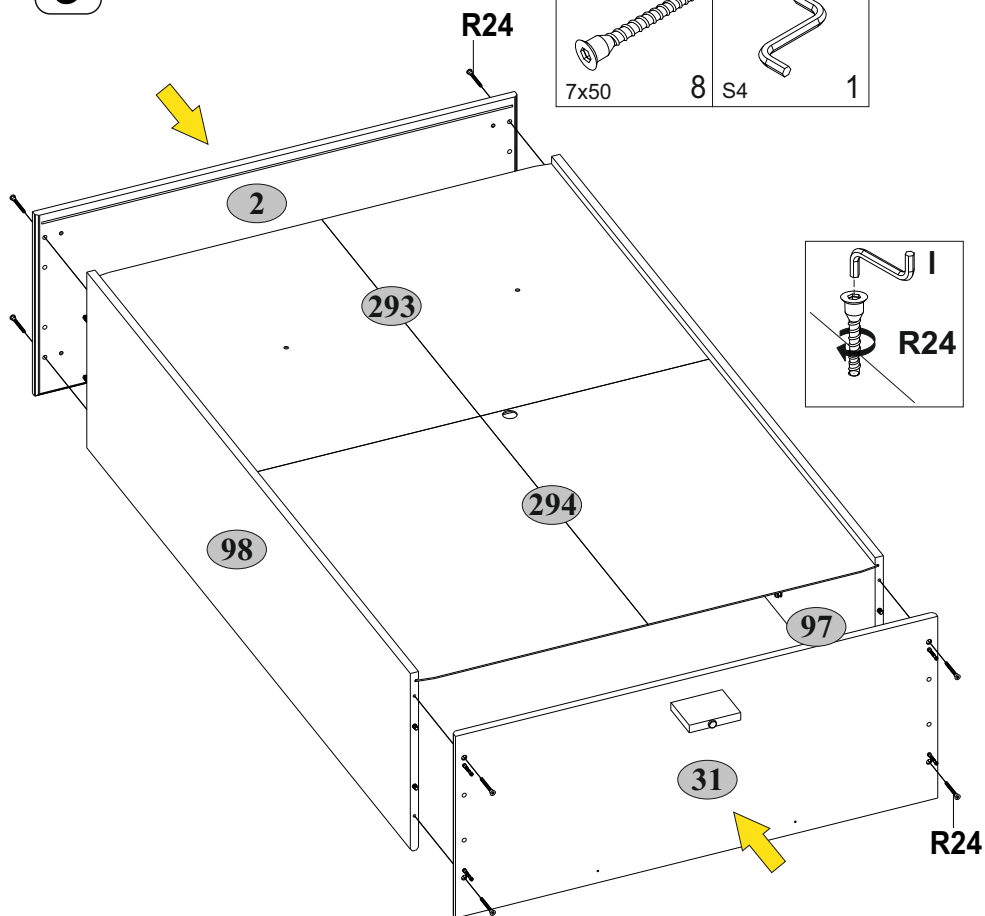

S4

1



R24

10

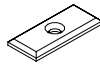
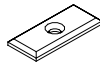
R3  3x20	S1  4	S3  20	S3  4
--	---	--	---

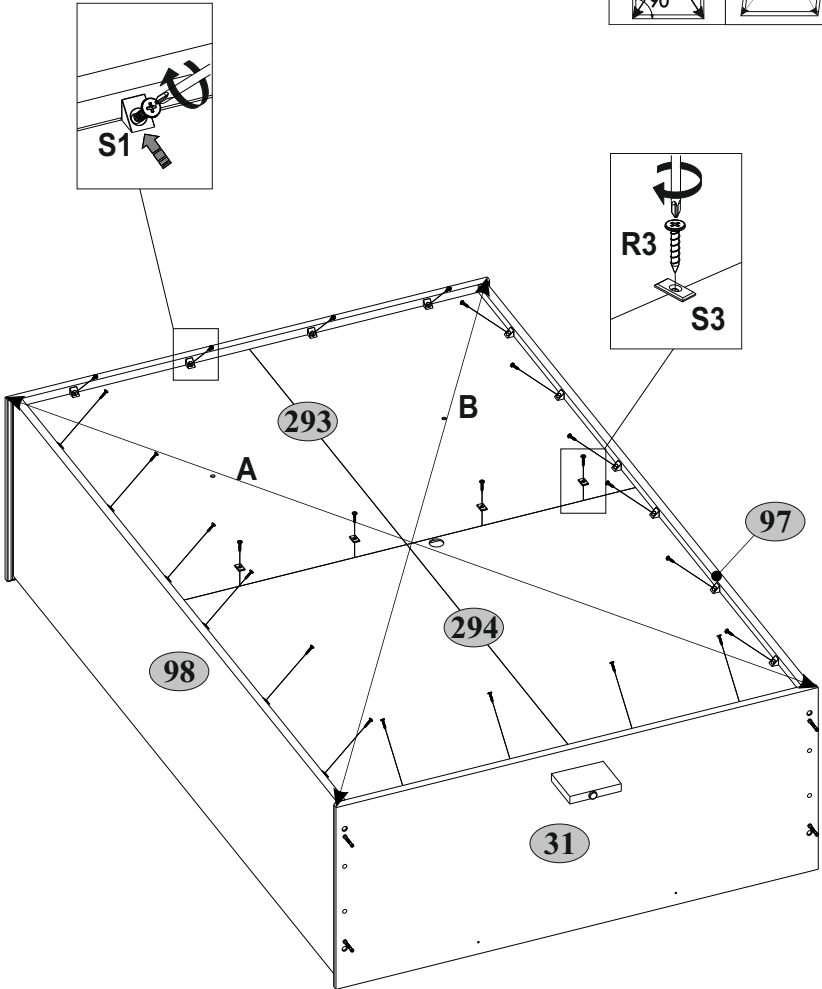
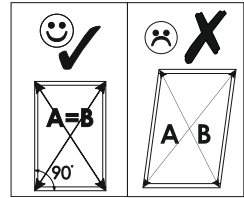
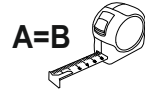

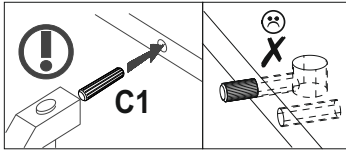
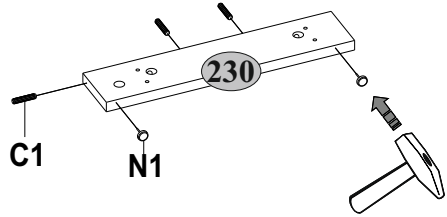
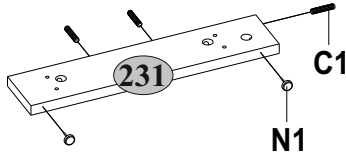
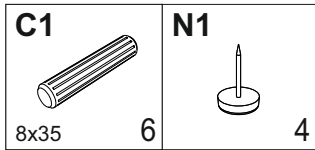
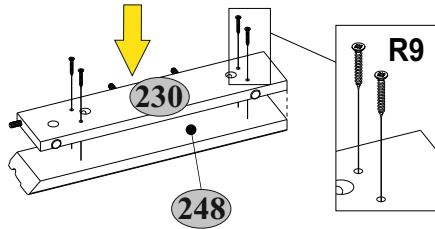
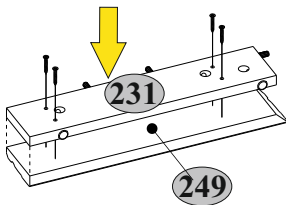
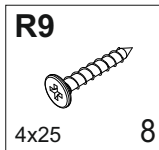
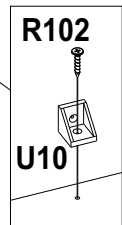
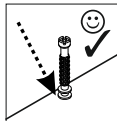
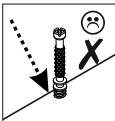
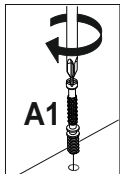
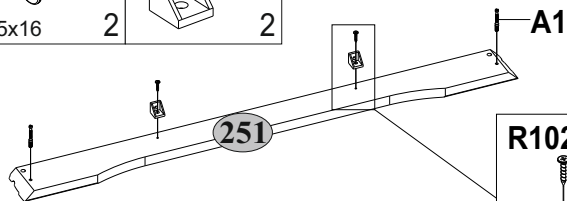
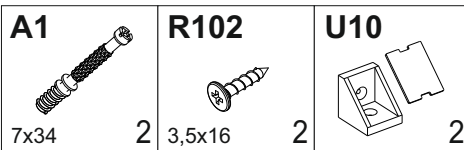
11**12****13**

14

A2



Ø15x12

2

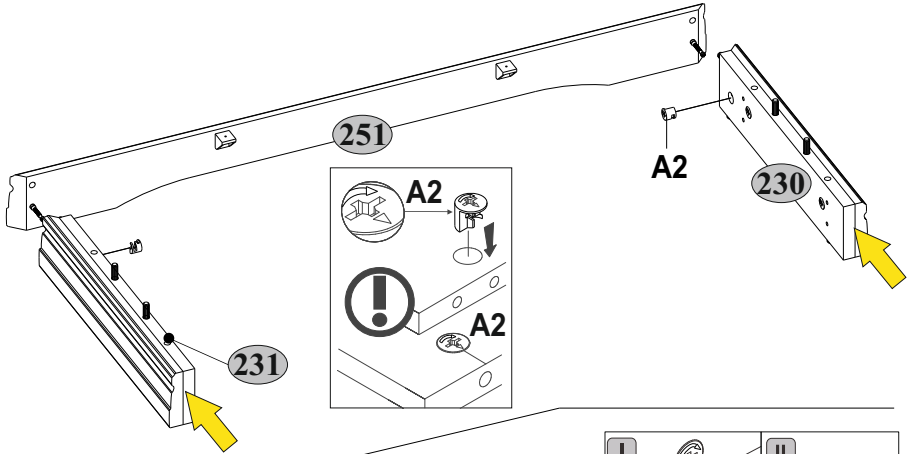
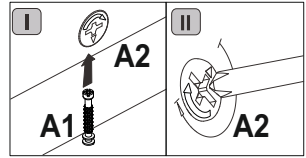

15

A2



Ø15x12

4

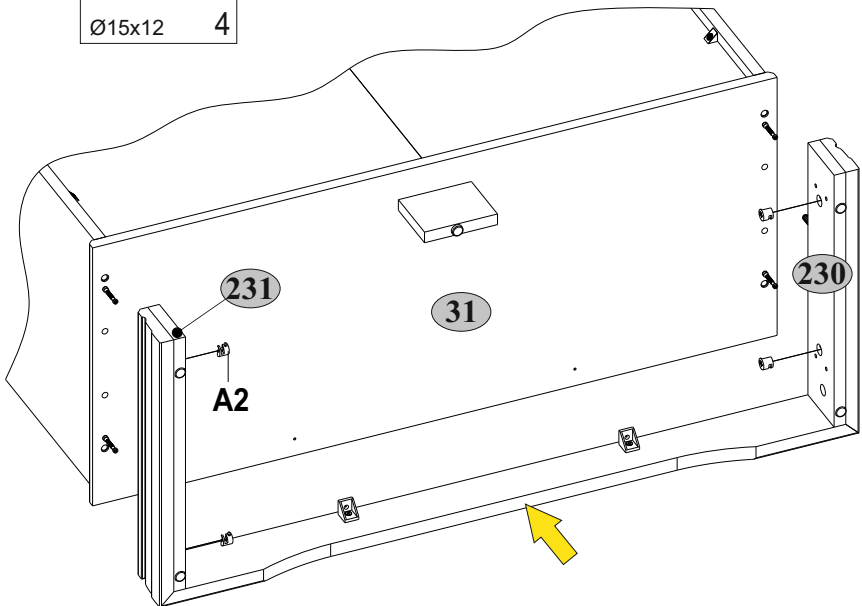
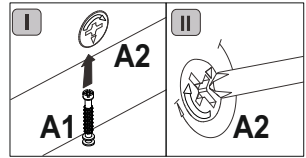

16

R102



3,5x16

2

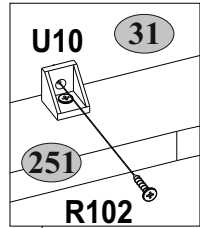
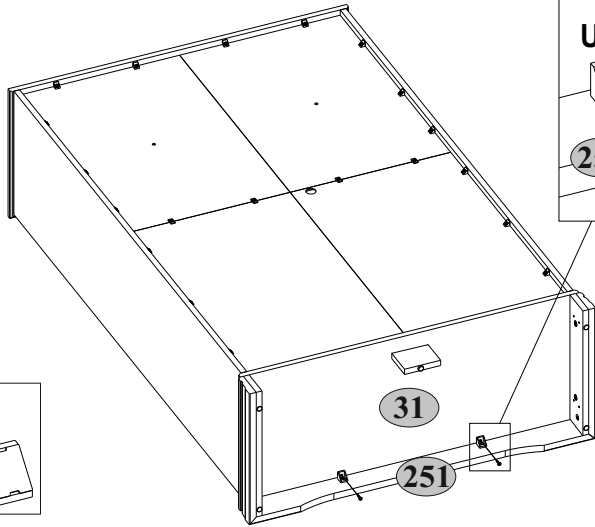

U10

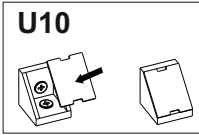

17

R105



3,5x30

S8





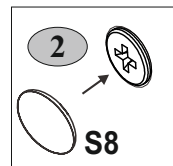
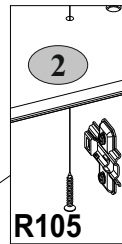
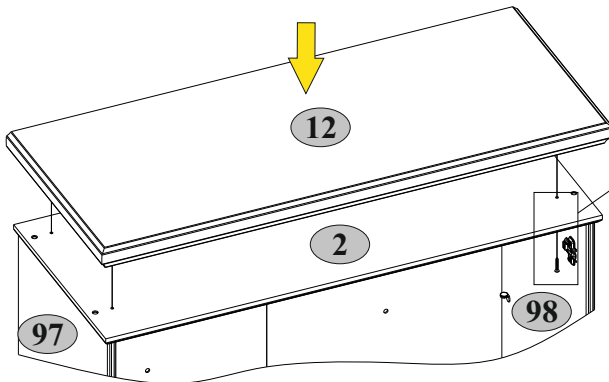

4

Ø14

4

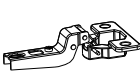
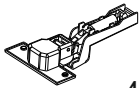

18



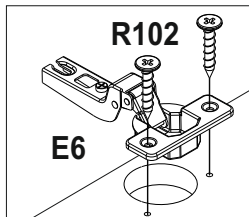
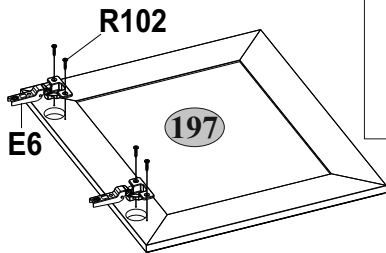



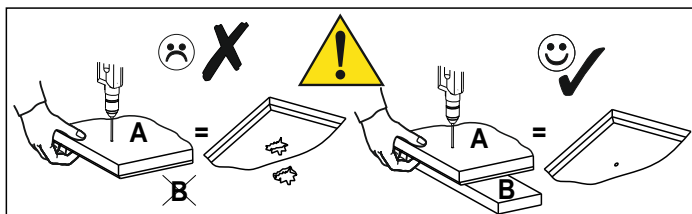
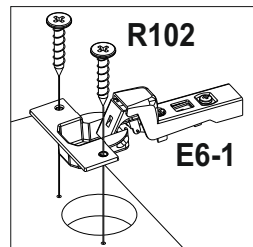
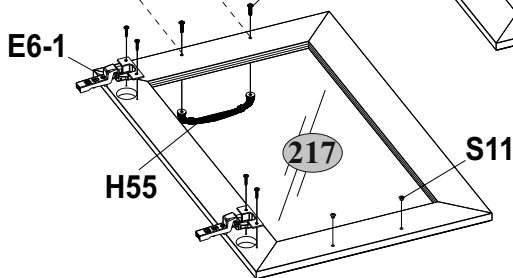
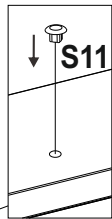
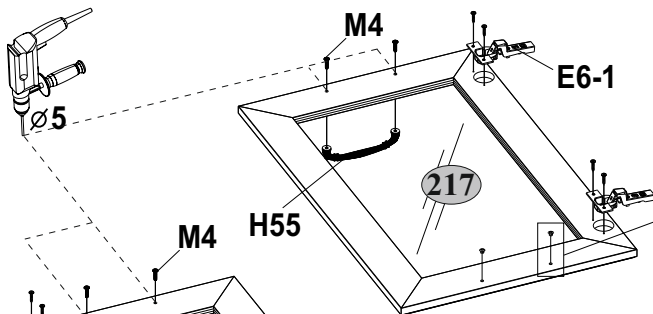
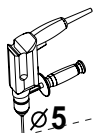
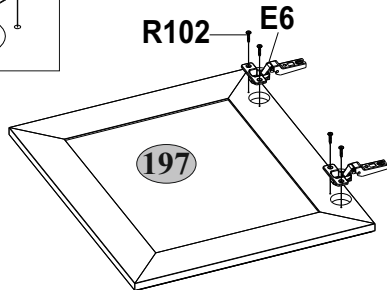

E6  4	E6-1  4	H55  2	M4  4 M4x22	S11  4 Ø8
---	---	--	---	---

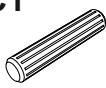

R102  3,5x16	16
--	----

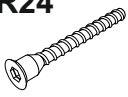

19

A1  7x34 5	A2  Ø15x12 4	C1  8x35 8	H56  1	I  S4 1
M1  M4x12 1	R24  7x50 4	S5  Ø18 4		

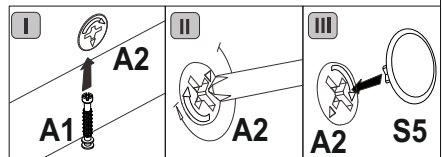
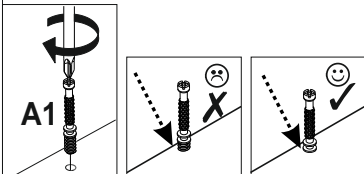
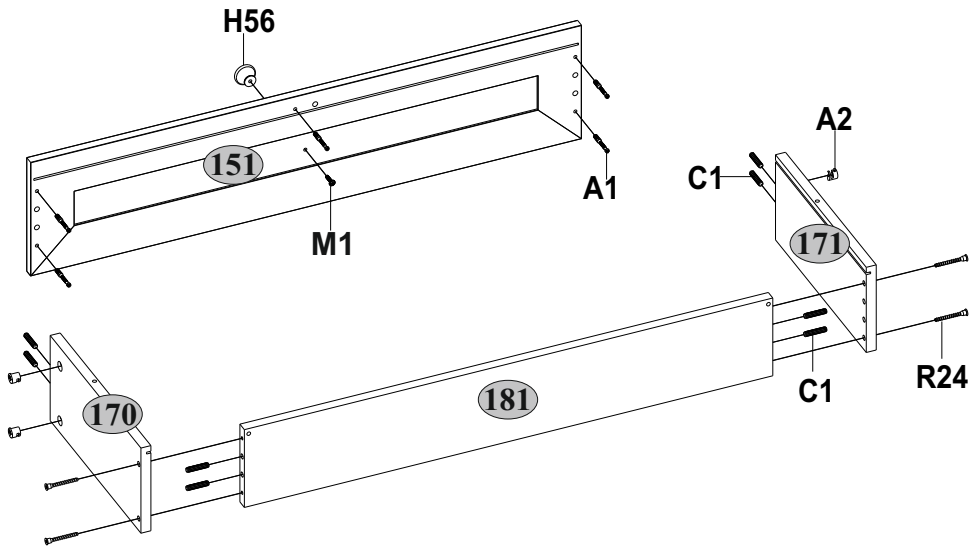
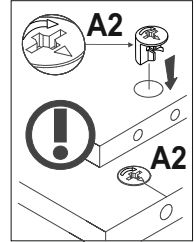
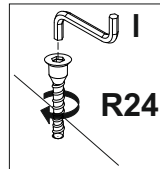
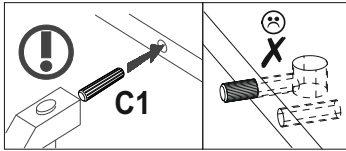

20

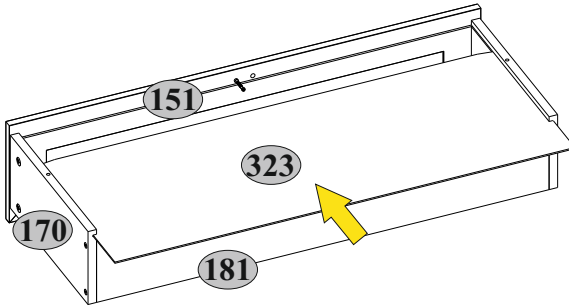

21

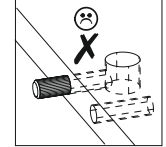
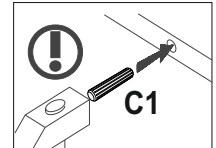
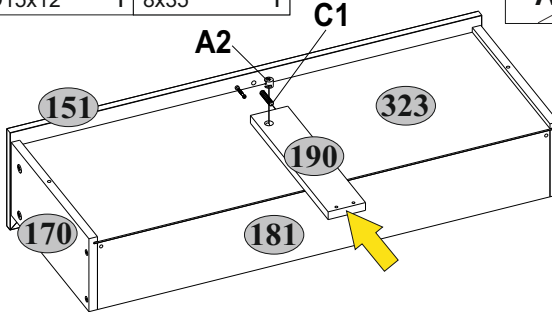
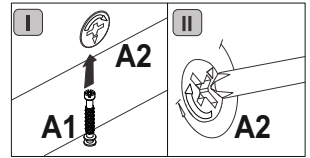
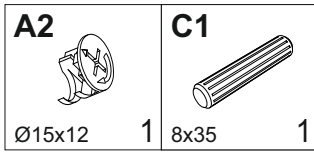

22

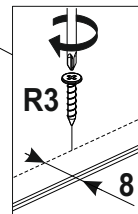
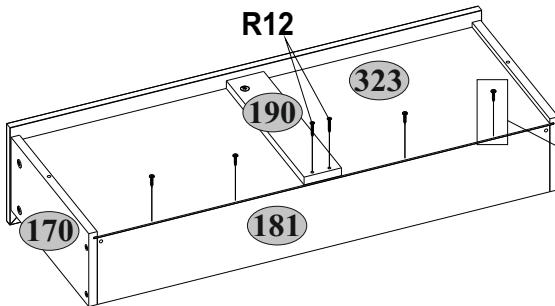
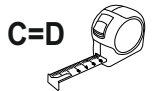
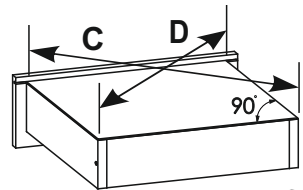
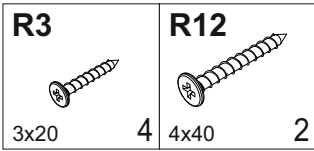

23

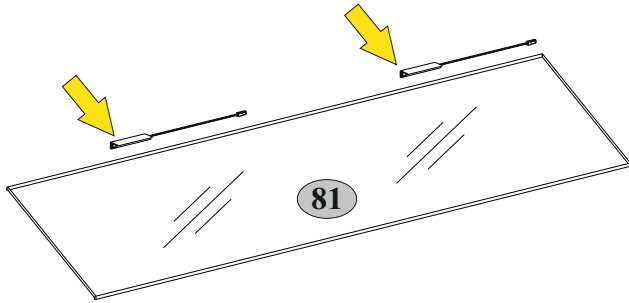
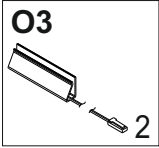

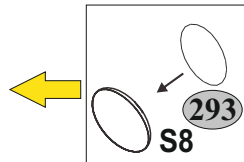
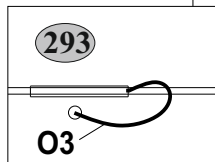
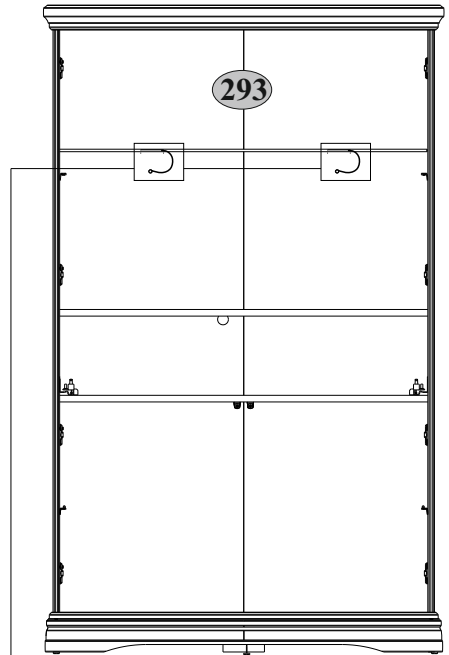
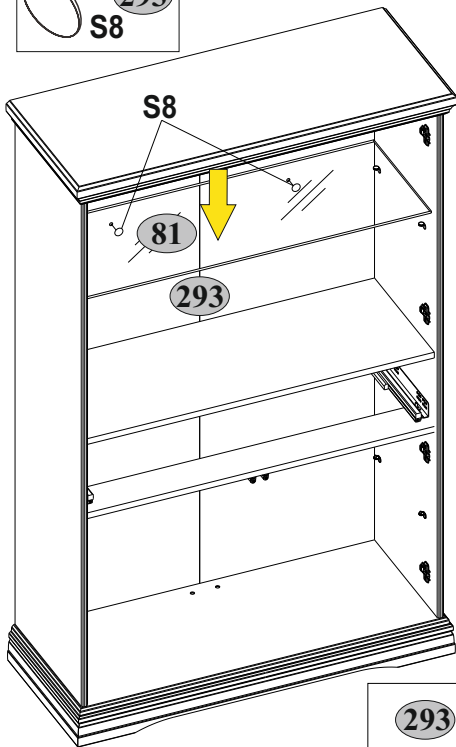
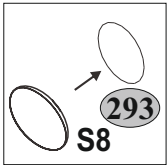
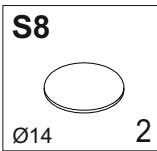

24

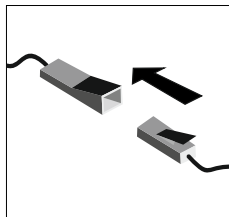
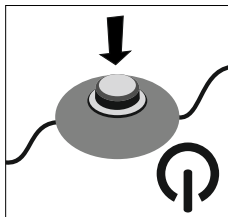
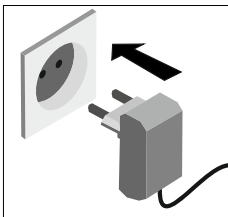
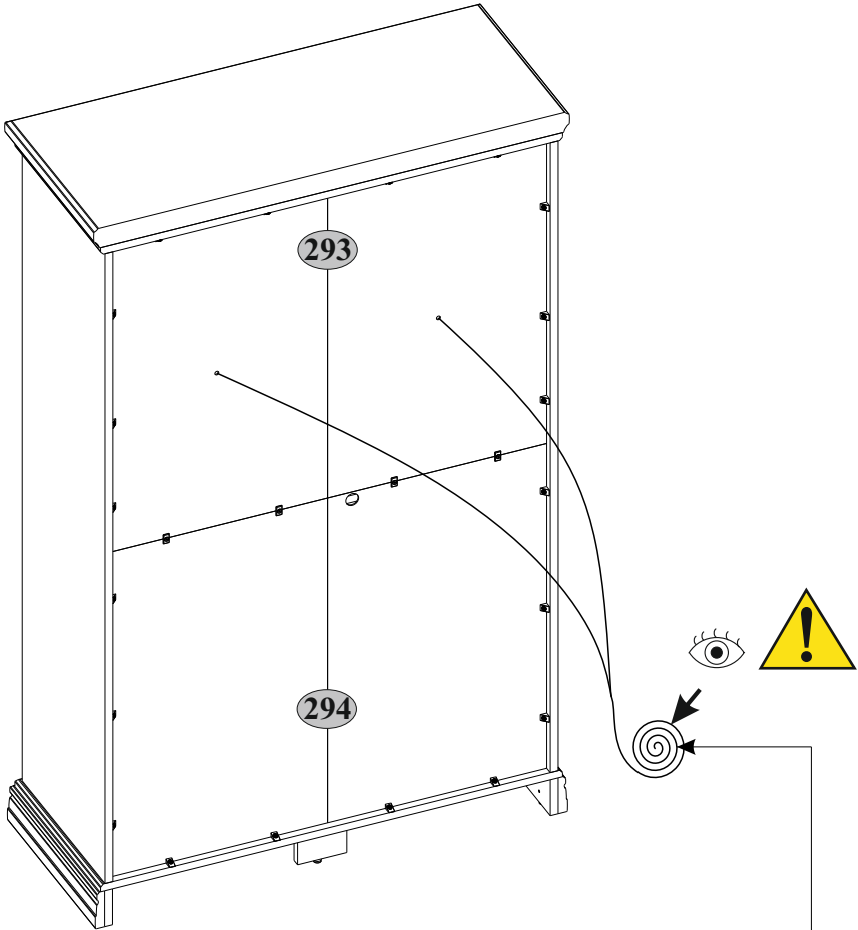
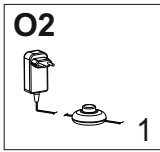

25



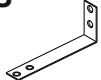

26

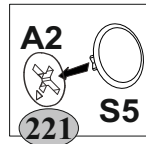
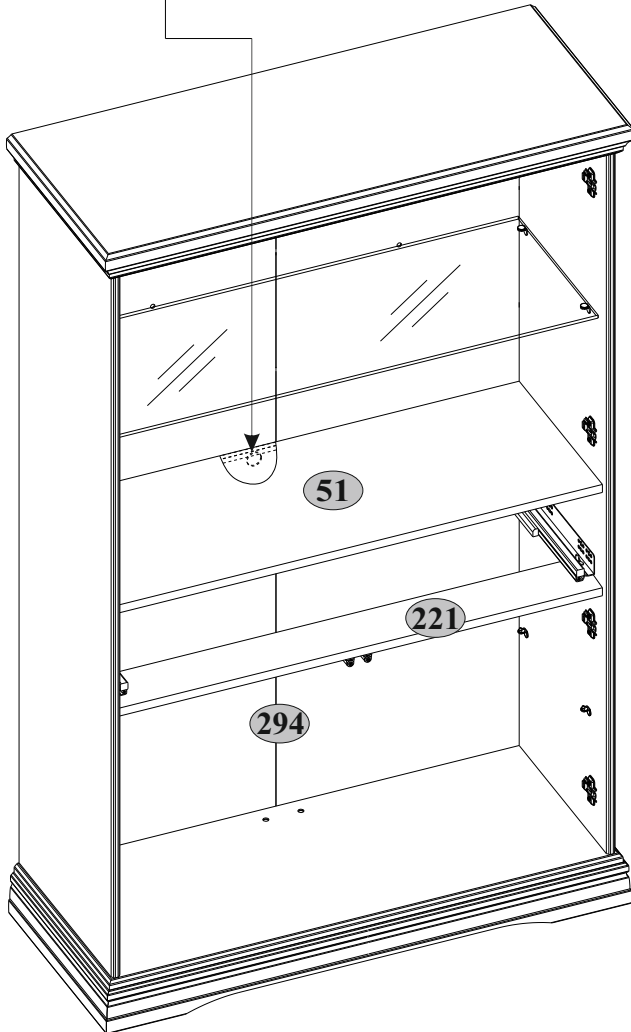
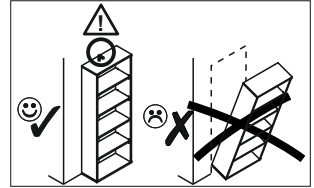
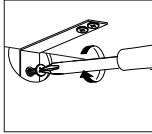
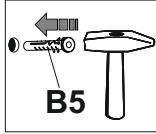
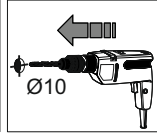
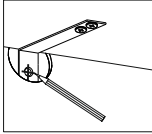
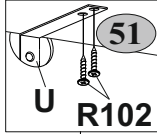
B5  10x50	S5  1 Ø18	R102  2 3,5x16	U  2 130x35x15
---	---	--	--

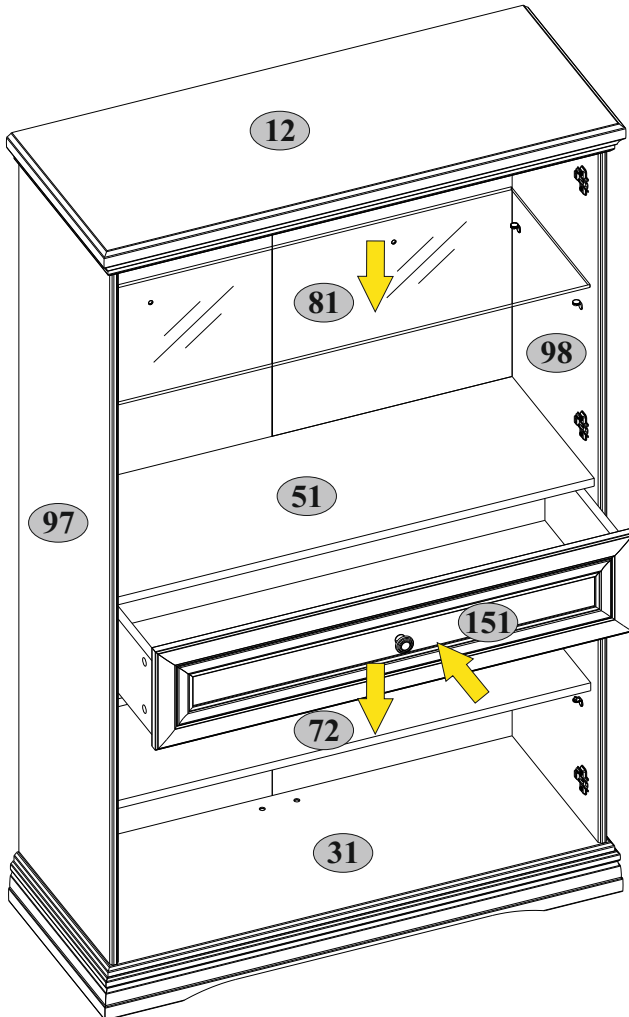
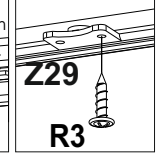
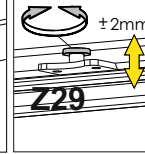
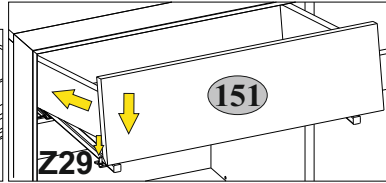
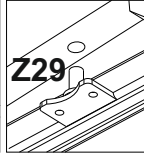
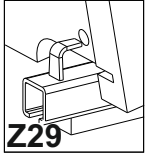
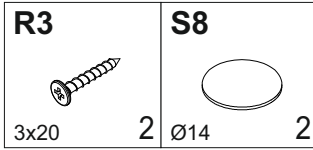

27

- (51) (72) (81)**  max. 5 kg
- (12) (151)**  max. 10 kg
- (31)**  max. 15 kg

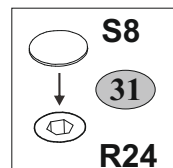

28

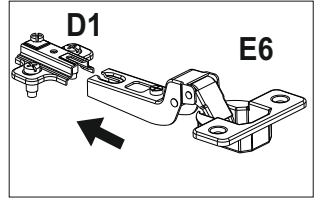

E6-1+D1-1

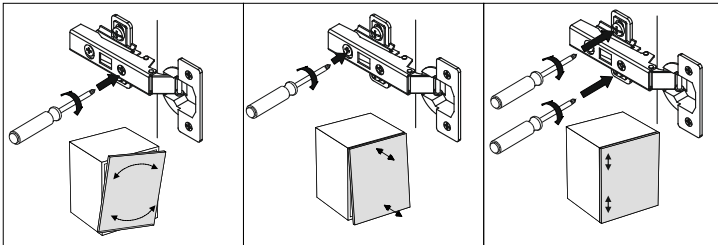
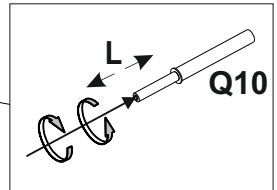
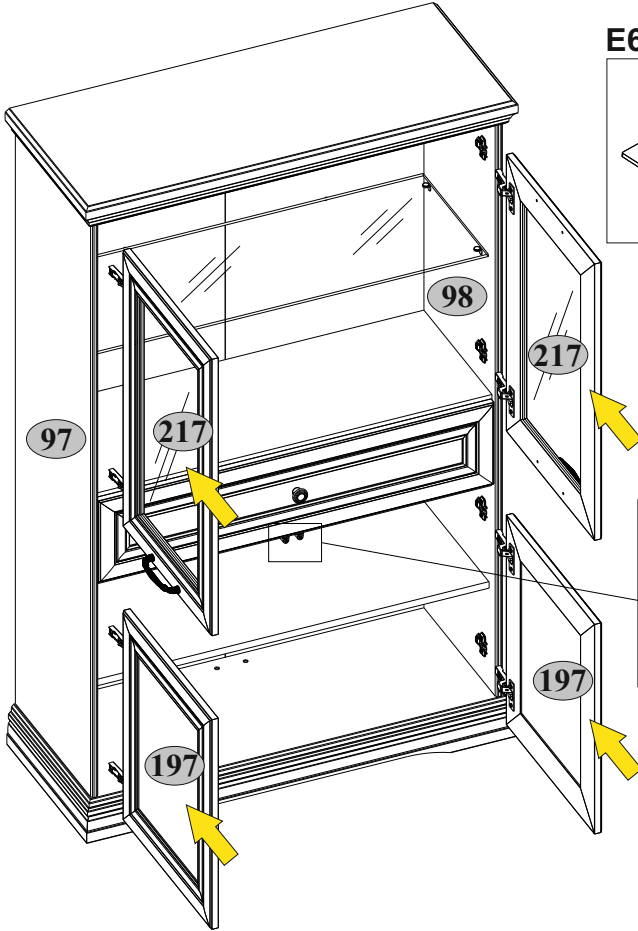
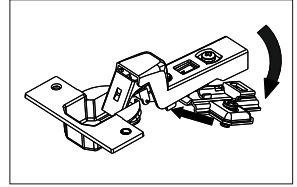

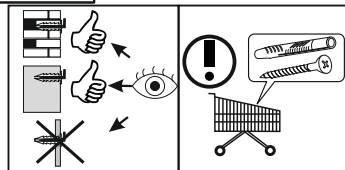
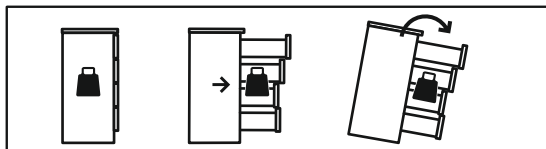

RU

ВНИМАНИЕ!

Опрокидывание мебели может стать причиной получения серьезных травм и привести к смерти.

Чтобы предотвратить опрокидывание, **ВСЕГДА** крепите мебель к стене с помощью фурнитуры, предотвращающей опрокидывание.

Вложенный дюбель используется для кирпичных и бетонных стен. Для крепления к стене используйте крепёж, подходящий для материала стен вашего дома, если вы не уверены какой тип крепления подходит для материала стен, обратитесь к специалисту или в специализированный магазин.

В конечном итоге ответственность за крепёж несёт специалист, осуществляющий монтаж.

В целях принятия мер дополнительной безопасности для предотвращения опрокидывания:

- Храните тяжелые предметы в нижнем ящике.
- Не ставьте тяжелые предметы сверху.
- Никогда не позволяйте детям залезать на ящики, дверцы или полки, а также виснуть на них.
- Используйте мебель по своему прямому назначению.

PL

OSTRZEŻENIE!

Przewrócenie się mebla może spowodować poważne lub śmiertelne obrażenia ciała na skutek przygniecenia.

ZAWSZE przymocuj ten mebel do ściany za pomocą ograniczników.

Kołek osadzony stosuje się do ścian z cegły i betonu. Do montażu na ścianie użyj łączników odpowiednich do materiału, z którego wykonana jest ściana, jeśli nie masz pewności, który rodzaj mocowania jest odpowiedni dla materiału ściennego, skontaktuj się ze specjalistą lub specjalistycznym sklepem. Ostatecznie za elementy złączne odpowiedzialny jest instalator.

Aby dodatkowo ograniczyć ryzyko poważnych obrażeń ciała i śmierci na skutek przewrócenia się mebla:

- Najcięższe przedmioty umieść w dolnej szufladzie.
- Nie kładź na wierzchu ciężkich przedmiotów.
- Nigdy nie pozwalaj dzieciom wspinać się na szuflady, drzwiczki lub półki.
- Używaj mebli zgodnie z ich przeznaczeniem.

EN

WARNING!

Serious or fatal crushing injuries can occur from furniture tip-over.

ALWAYS secure this furniture to the wall using tip-over restraints.

The embedded dowel is used for brick and concrete walls. For wall mounting, use fasteners suitable for the wall material of your home, if you are not sure which type of fastening is suitable for the wall material, contact a specialist or a specialized store. Ultimately, the installer is responsible for the fasteners.

To further reduce the risk of serious injury and death from tip-overs:

- Place heaviest items in the lower drawer.
- Do not leave objects on top of this product.
- Never let children climb or hang on drawers, doors, or shelves.
- Use the furniture for its intended purpose.